

# Fumis



## Fumis Premium

Intuitive touch screen user interface

### User Guide



*Document version 1.0\_013*

*August, 2015*

---

## Legal notices

---

Fumis products are intended for controlling the process of biomass combustion in wood biomass heating systems (pellets, cutter chips, firewood) and wood-like biomass (pallets and briquettes from another biomass, shells, vegetable grains and the like). Under certain circumstances, the functioning of these devices can cause, among others, the following risks: a) when the device is not used appropriately, an excess amount of explosive mixture of wood gas and air can be produced in the device which may explode; b) in case of misuse and excessive overheating of the device the pressure inside the boiler can become too high and the boiler can explode; c) during combustion, carbon monoxide is produced inside the device. In the case that inappropriate carbon monoxide fumes are produced, they can threaten the health and life of people and animals.

The aforementioned explosions are powerful enough to produce damage to the combustion device, nearby devices and also to the building where the device is installed. People within the vicinity of the device can be injured.

To avoid the aforementioned risks the buyer or any third party that purchases, assembles or sets up the Fumis product or device (hereinafter, for the needs of this section, "the buyer") is, with the purchase of the Fumis product, and/or assembly and/or setting up of the device containing the Fumis product, are obligated to ensure that the device, in which the Fumis product will be/is installed, will be planned, implemented and maintained to a high standard. Thus assuring that the possibility of the aforementioned risks and other dangers are minimal. The buyer is also responsible for insuring that any necessary safety devices will be installed to prevent any danger that may occur, and that the Fumis product will only be installed into devices that are safely compatible with the Fumis product. In addition, the buyer is responsible for assuring, that the device will be installed professionally and in accordance with proper electrical and hydraulic schematics, and that parameters on the device and on the Fumis product will be at all times within such limits, to ensure safe operation of the whole device and that the device will be used exclusively in accordance with its purpose and all precautions necessary to assure safety. The buyer also guarantees that servicing and maintenance procedures will be done so that the functioning of the whole device will be safe, and is pledging, that each potential adjustment or setting of the Fumis product or the device operation will be made so that the whole device will be safe. With the purchase, installation or use of the device or with installment of the device, the buyer agrees to assume full responsibility for any damage that could be prevented by proper usage or installation of the Fumis product or the whole device, or by consistent respect of the specified obligations, and in accordance with care of an expert thus releasing the producer of the Fumis from any responsibility for damage that may occur.

This document contains copyrighted information and materials. These materials are provided for informational purposes only. You may not sell, alter, modify, license, sublicense, copy, or use the information and materials in any way other than specifically permitted by ATech elektronika d.o.o..

All information and materials are provided on "as is" basis, and are subject to change without prior notice. ATech elektronika d.o.o. (Ltd.) shall not be liable for any damages that may result from use of these information and materials.

© Copyright ATech elektronika d.o.o. (Ltd.), 2012. All rights reserved.

For information visit [www.ATech.sj](http://www.ATech.sj), or contact:

ATech elektronika d.o.o.  
Bač pri Materiji 30  
6242 Materija

Sales: [sales@Fumis.si](mailto:sales@Fumis.si)  
Technical support: [support@Fumis.si](mailto:support@Fumis.si)

## Abstract

---

This document is intended for the final users of combustion systems, controlled by Fumis Alpha controller and Fumis Premium user interface. It contains general information and instructions on how to use the Fumis Premium user interface. Descriptions and instructions for combustion systems (or other systems) are not included in this document.

This document contains the following:

- General description of the Fumis Premium parts/connectors
- Fumis Premium mounting instructions
- General information on the operation of Fumis Premium
- Troubleshooting information for the Fumis Premium

## Warnings and recommendations

---

Fumis products have been designed in accordance to applicable industrial standards and good engineering practices to provide safe and reliable operation.

In order to use the Fumis Premium, carefully read and observe the recommendations and warnings in this chapter and in this User guide in general.

ATech elektronika d.o.o. recommends to manufacturers of heating and combustion systems to integrate these recommendations and warnings in their product user guides and manuals to the extent as applicable.

The combustion system manufacturer has the right to use, reproduce and distribute parts of this document in their own documentation related to products using Fumis controllers. Whoever uses this document or its parts by doing so assumes all the risks and responsibilities that may derive from or are a consequence of such use. In such cases ATech Elektronika d.o.o. does not makes any warranty, express or implied, or assumes any liability or responsibility for the use of this information.

## Warnings

### **Exposure to water and other liquids**

Do not expose the product to water, cleaning agents, solvents or any other liquids as it may damage the electronics, cause malfunctions or failure and pose a threat to life.

When using the product avoid the possibility of water or other liquids coming in contact with the electronics. Any contact of water or other liquids may damage the electronics, cause malfunctions or failure and pose a threat to life.

### **Modifying parameters**

Fumis premium allows parameter modifications only through a special menu (Service menu) accessible through a dedicated password. Modifying the parameters may alter the combustion system function, cause malfunction and even cause damage, ATech advises that customers allow only trained professionals to modify the parameters and not the final user.

## Recommendations

### Cleaning

To clean the Fumis Premium user interface gently wipe it with a dry cloth. To remove grease stains gently wipe the unit using a cloth with a minimum amount of mild detergent.

### Servicing

The FUMIS Alpha controllers and accessories have been designed for long-life operation and do not require special maintenance. However, in case of malfunctions, ATech elektronika d.o.o. strongly recommends that servicing be carried out by trained authorised personnel only.

## Warranty and general conditions

---

ATech elektronika d.o.o. guarantees Fumis products against errors in material and workmanship for 1 year after delivery.

The warranty period starts on the day of delivery and is pending on the professional handling of the product, as described in this guide.

ATech elektronika d.o.o. reserves the right to apply technical modifications without prior notice.

ATech elektronika d.o.o. is not liable for malfunction and injuries that are a consequence of:

External, chemical and physical influences during transport, storage, installation and use of Fumis products (as for example, but not limited to water leakage, exposure of the electronics to steam, exhaust fumes, ash and temperatures above the specification).

---

# Contents

---

1. Technical characteristics.....	9
2. General description of the Fumis Premium parts/connectors.....	10
3. Fumis Premium mounting instructions.....	10
4. General information on the operation of Fumis Premium.....	12
4.1. Power supply.....	12
5. Getting started.....	12
5.1. Removing the transparent protective film.....	12
5.2. Connecting the heating device to the power supply.....	12
5.3. Setting the language.....	12
5.4. Setting the date and time.....	12
5.5. Setting the temperature unit.....	12
6. Fumis Premium functions.....	13
6.1. General icons description.....	13
6.2. Idle mode.....	14
6.3. Setting the date and time.....	15
6.4. Setting the target temperature.....	16
6.4.1. Setting the ambient temperature.....	16
6.4.2. Setting the 2 <sup>nd</sup> ambient temperature.....	16
6.4.3. Setting the water temperature.....	16
6.4.4. Switching between setting the AIR and/or WATER temperature.....	17
6.5. Turning on the heating device.....	17
6.5.1. Manually through Fumis Premium.....	17
6.5.2. Manually through IR remote control unit.....	18
6.5.3. Automatically by weekly timers.....	19
6.5.4. Automatically by Eco Mode.....	19
6.6. Changing/selecting the operating power level.....	20
6.7. Changing/selecting the ambient fan speed.....	20
6.8. Setting the weekly timers.....	21
6.9. Viewing service counters.....	22
6.10. Setting fuel options.....	23
6.10.1. Setting the fuel type.....	23
6.10.2. Setting the fuel quality.....	24
6.10.3. Enabling the fuel autonomy monitoring.....	24

6.10.4. Resetting the fuel autonomy after refilling the fuel tank ..... 25

6.11. Display brightness..... 25

    6.11.1. Setting the automatic brightness adaptation ..... 26

    6.11.2. Setting the active display brightness ..... 26

    6.11.3. Setting the idle display brightness ..... 27

6.12. Enabling the Eco Mode function ..... 27

6.13. Idle display mode settings ..... 28

6.14. Setting the temperature unit (°C/°F)..... 29

6.15. Setting the speaker volume..... 30

6.16. Setting the antifreeze temperature..... 30

6.17. Using the manual feeding function ..... 31

6.18. Checking the time to service ..... 32

6.19. Using the screen lock function ..... 32

6.20. Using the display cleaning function..... 33

6.21. Setting the language..... 34

6.22. Checking the firmware version..... 34

6.23. Using the tips..... 35

6.24. Entering into the service menu ..... 35

    6.24.1. Modifying the parameters ..... 35

    6.24.2. Input and output diagnostics ..... 36

    6.24.3. Viewing and resetting the service counters..... 36

    6.24.4. Viewing logs ..... 36

7. Troubleshooting ..... 36

7.1. Alerts and errors..... 37

7.2. Resetting the alerts and errors..... 39

    7.2.1. Resetting the alerts ..... 39

    7.2.2. Resetting the errors ..... 39



# About Fumis Premium user interface

Fumis Premium is a new generation user interface. Thanks to its shape, touch screen technology and intuitive operation, which is very similar to the logic of modern smart devices, this user interface is very eye-catching when placed in the user's everyday life.

Fumis Premium key benefits:

- Easy and intuitive to use (the product guides the user how to use it)
- Modern design, similar to smartphone devices
- Compatibility with all types of Fumis controllers
- Does not require special programming skills or training
- Remote control option
- Automatic adjustment of screen brightness
- The ability to change themes/wallpapers (on request)
- Easy installation
- Easy replacement of the existing Fumis user interface (simply disconnect the existing Fumis user interface and connect the Fumis Premium)
- Easy to clean

## 1. Technical characteristics

Temperature range	-20°C to +70°C (storage); -20°C to +70°C (operating)
Humidity range	Max. 95%, non condensing
Ingress protection class	IP20 (at recommended mounting position)
Screen type	TFT capacitive touch screen, min. 65k colours, swipe function supported
Screen resolution	400 x 240 pixels; 69,6x41,76mm – diagonal 3,2" (81mm)
Host controller connection	Proprietary protocol
Connections	Micro USB connector MSD class (firmware update) and RJ11 connector (communication with Fumis controller)
Supply	directly from Fumis controller, 5Vdc; 200mA max.
Mounting	4 screws

Table 1 – Technical characteristics

---

## 2. General description of the Fumis Premium parts/connectors

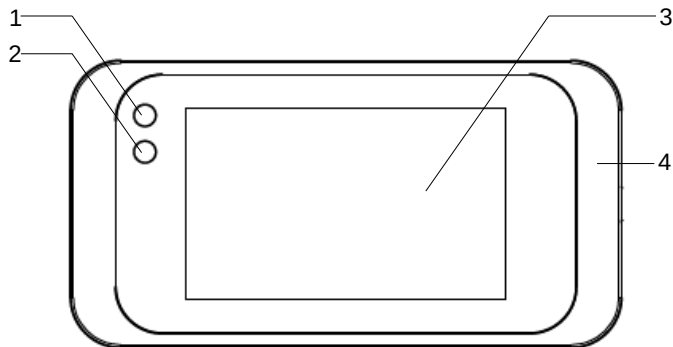

Figure 1 – front view

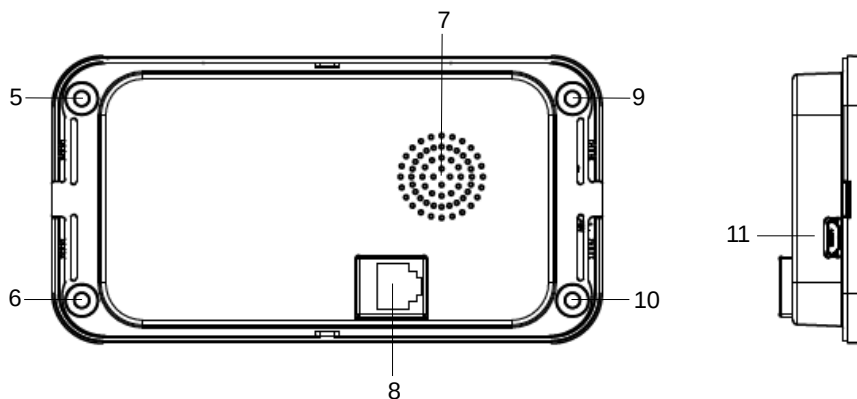

Figure 2 – Back view (figure on the left) and side view (figure on the right)

### LEGEND:

- 1 → Ambient light sensor
- 2 → IR receiver
- 3 → Sensitive (touch) surface
- 4 → Plastic frame
- 5, 6, 9, 10 → Mounting holes
- 7 → Speaker
- 8 → RJ11 connector (communication with Fumis controller and power supply of the Fumis Premium)
- 11 → Micro USB (firmware update)

## 3. Fumis Premium mounting instructions

The Fumis Premium can be mounted onto the combustion system in three different ways:

- Prepare four M3 threaded rivets and use the M3 screws to fix the Fumis Premium. Any type of M3 filleted rivet with 0.5 mm maximum height above the mounting surface can be used.
- Prepare the M3 threads and use the M3 screws to fix the Fumis Premium.
- Use four self-tapping screws ST29 to fix the Fumis Premium.

**Note:**

Always use flat-head screws.

It is advised to install the Fumis Premium so that the back side of it is not accessible to the final user.

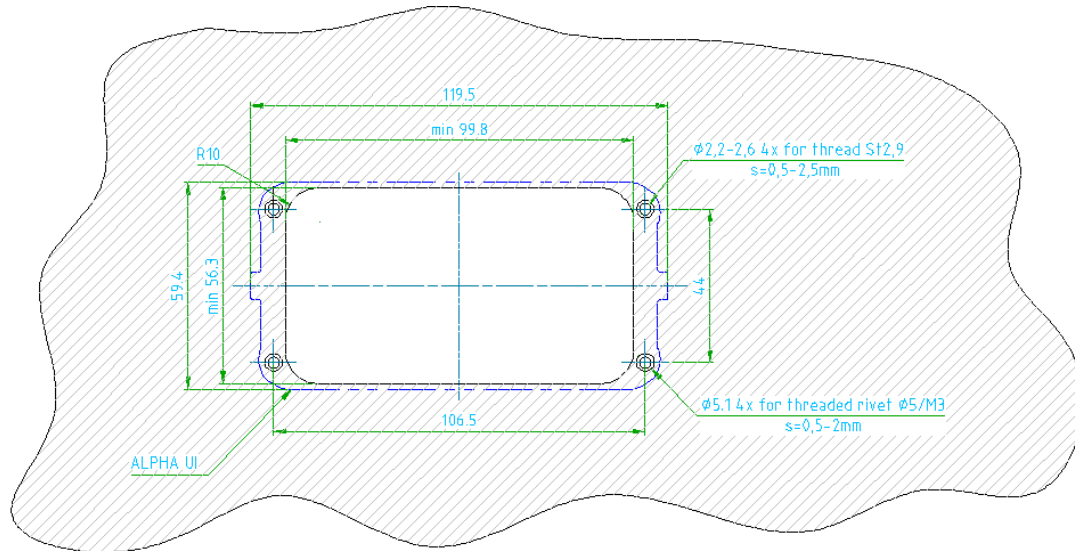

Figure 3: Cut-out dimensions and hole positions for Fumis Premium

**IMPORTANT**

The maximum length of the cable between the Fumis controller and the Fumis Premium is 10m. Use the RJ11 connection cable, available at ATech elektronika d.o.o..

It is advised that the Fumis Premium connecting cable is mounted so that it is not bent with a radius smaller than 15mm. In case the Fumis Premium is mounted on a movable part (for example, on the reservoir lid), make sure the cable is not overstressed during the movement and at both end positions. In this case it is recommended the cable is not bent with a radius smaller than 20mm.

---

## 4. General information on the operation of Fumis Premium

### 4.1. Power supply

The Fumis Premium needs a power supply to operate. The power supply comes from the controller, through the cable connected into the RJ11 connector (see figure 2).

**Note:**

Do not connect the Fumis Premium to an external micro USB power supply (for example telephone chargers).

## 5. Getting started

### 5.1. Removing the transparent protective film

It is recommended that you remove the protective film before using the Fumis Premium user interface to guarantee the best performance of the sensitive (touch) surface.

### 5.2. Connecting the heating device to the power supply

Connect the heating device to the power supply (follow the instructions on your heating device).

### 5.3. Setting the language

Set the desired language (for details see chapter 6.21.).

### 5.4. Setting the date and time

Set the correct date and time on the Fumis Premium (for details see chapter 6.3.).

### 5.5. Setting the temperature unit













Set the temperature unit (°C or °F) you want to be appear on the Fumis Premium (for details see chapter 6.14.).

**Note:**

Before turning on the heating device read this guide carefully.

## 6. Fumis Premium functions

### 6.1. General icons description

ICON	DESCRIPTION	ACTION
	Enter temperature menu	Touch
	Check the current ignition/shutting down state	Touch
	Enter main menu	Touch
	Increase	Touch OR hold
	Decrease	Touch OR hold
	Enter timers menu	Touch
	Enter statistics menu	Touch
	Enter settings menu	Touch
	Enter tips menu	Touch
	Turn ON the heating device	<b>Hold</b>
	Turn OFF the heating device	<b>Hold</b>
	Screen lock set to HIGH	Touch











	Screen lock set to LOW	Touch
	Close the menu	Touch
	Navigate back	Touch
	Previous sub menu page	Touch
	Next sub menu page	Touch
	Info about the selected submenu	Touch
	Fuel autonomy monitoring/resetting (if enabled in the Fumis Premium and supported by the heating devices software)	Touch
	ON -->enable; OFF --> disable	Touch
	Confirm	Touch
	Delete	Touch
	Start the feeder motor manually (only when the heating device is OFF)	<b>Hold</b>

Table 2 – Icons description

## 6.2. Idle mode

Fumis Premium automatically switches to idle mode after 30 seconds of inactivity and exits from it when touched again. Depending on the settings for the idle mode, the screen in idle mode displays:

- the clock only
- the AIR temperature (if AIR temperature enabled in the heating devices software) only
- the WATER temperature (if WATER temperature enabled in the heating devices software) only
- Switching between the clock and AIR temperature (if AIR temperature enabled in the heating devices software)

- Switching between the clock and WATER temperature (if WATER temperature enabled in the heating devices software)
- Switching between the clock, AIR temperature and WATER temperature (if AIR and WATER temperature enabled in the heating devices software)
- The state of the heating device (when the heating device is in OFF state)
- The fuel autonomy (if enabled in the Fumis Premium and supported by the heating devices software)
- Errors/alerts (if present)

For details see chapter 6.13.

**Note:**

It never switches to idle mode from the service menu.

## 6.3. Setting the date and time



- Touch the screen (if currently in idle mode) to exit from the idle mode. If the display currently is not in idle mode, skip this step.

- Tap on  to enter the temperature menu



- Tap on  to enter the main menu

- Tap on  to enter the settings menu

- Tap on **"Time"** to enter the **Time** menu

- Set up **Hours**, **Minutes** and **Day of the week** by tapping on  and/or  icons. After completing the settings, save them by tapping on .

- Tap on **"Date"** to enter the **Date** menu

- Set up the **Day**, **Month** and **Year** by tapping on  and/or  icons. After completing the settings, save them by tapping on .

**Note:**

Pay attention in setting up the date and time properly. Otherwise the weekly timers will not perform when desired.

---

## 6.4. Setting the target temperature

Depending on the heating devices configuration, Fumis Premium allows you to set the target temperature of the ambient (AIR temperature), 2<sup>nd</sup> ambient (ROOM 2 temperature) and water (WATER temperature). The unsupported functions by your heating device will not be displayed.

### 6.4.1. Setting the ambient temperature

- Touch the screen (if currently in idle mode) to exit from the idle mode. If the display currently is not in idle mode, skip this step.

- Tap on  to enter the temperature menu

- The screen is now displaying the currently set ambient temperature (AIR temperature):

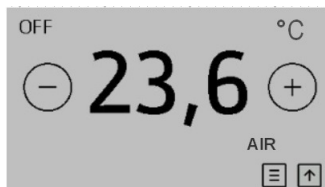

- Change the target temperature by tapping on  and/or  icons. The changes are saved immediately.

### 6.4.2. Setting the 2<sup>nd</sup> ambient temperature

If the heating device supports setting both, AIR and ROOM 2 temperature, you can switch between setting one or the other by tapping on the labels "AIR" or "ROOM 2".



- Change the target temperature by tapping on  and/or  icons. The changes are saved immediately.

### 6.4.3. Setting the water temperature

- Touch the screen (if currently in idle mode) to exit from the idle mode. If the display currently is not in idle mode, skip this step.

- Tap on  to enter the temperature menu

- The screen is now displaying the currently set water temperature (WATER temperature):



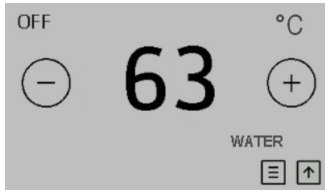

- Change the target temperature by tapping on  and/or  icons. The changes are saved immediately.

#### 6.4.4. Switching between setting the AIR and/or WATER temperature

If the heating device supports setting both, AIR and WATER temperature, you can switch between setting one or the other by tapping on the labels "AIR" or "WATER". To change the target temperatures follow chapters 6.4.1 (for AIR temperature) and 6.4.3 (for WATER temperature).

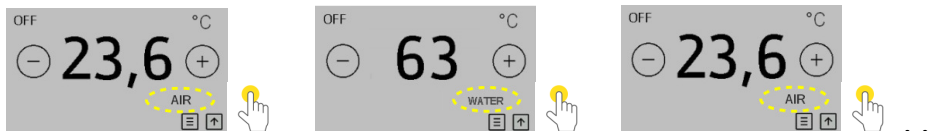

### 6.5. Turning on the heating device

#### 6.5.1. Manually through Fumis Premium

Fumis Premium user interface allows you to turn on the heating device in two different ways (see below "Option A" and "Option B").

**Note:**

The heating device can be turned on only when its current state is off (the label "OFF" present in the upper left corner of the screen).

a.) Option A:

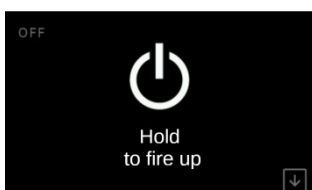

- Touch the screen (if currently in idle mode) to exit from the idle mode. If the display currently is not in idle mode, skip this step.
- **Hold** the center of the screen below:

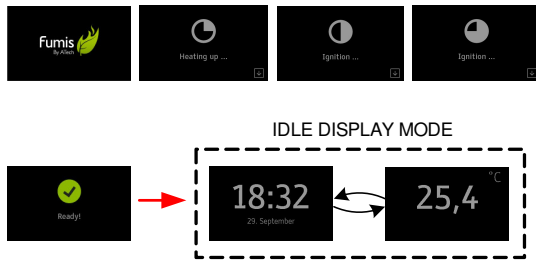

The following screens will appear as follows:



b.) Option A:

- Touch the screen (if currently in idle mode) to exit from the idle mode. If the display currently is not in idle mode, skip this step.
- Tap on  to enter the temperature menu
- Tap on  to enter the main menu
- **Hold**  to turn on the heating device

The following screens will appear as follows:

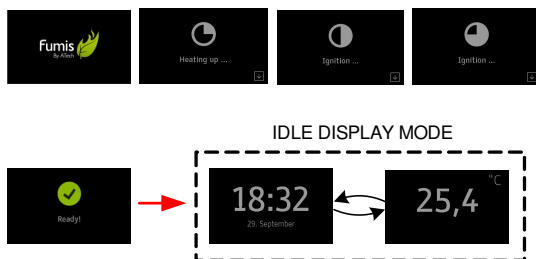

## 6.5.2. Manually through IR remote control unit

As the Fumis Premium has an IR receiver integrated, the heating device can be turned on also by using the Fumis IR remote control unit (order code: 8620022).

**Note:**

The Fumis IR remote control unit also allows you to change the operating power level of the heating device, as well as changing the ambient fan speed (if the heating device includes the ambient fan).

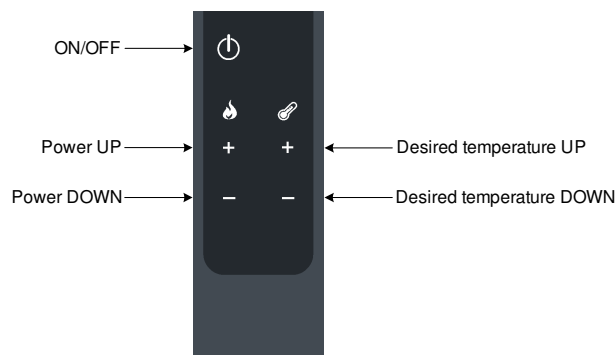

Figure 4: Fumis IR remote controller (buttons description)

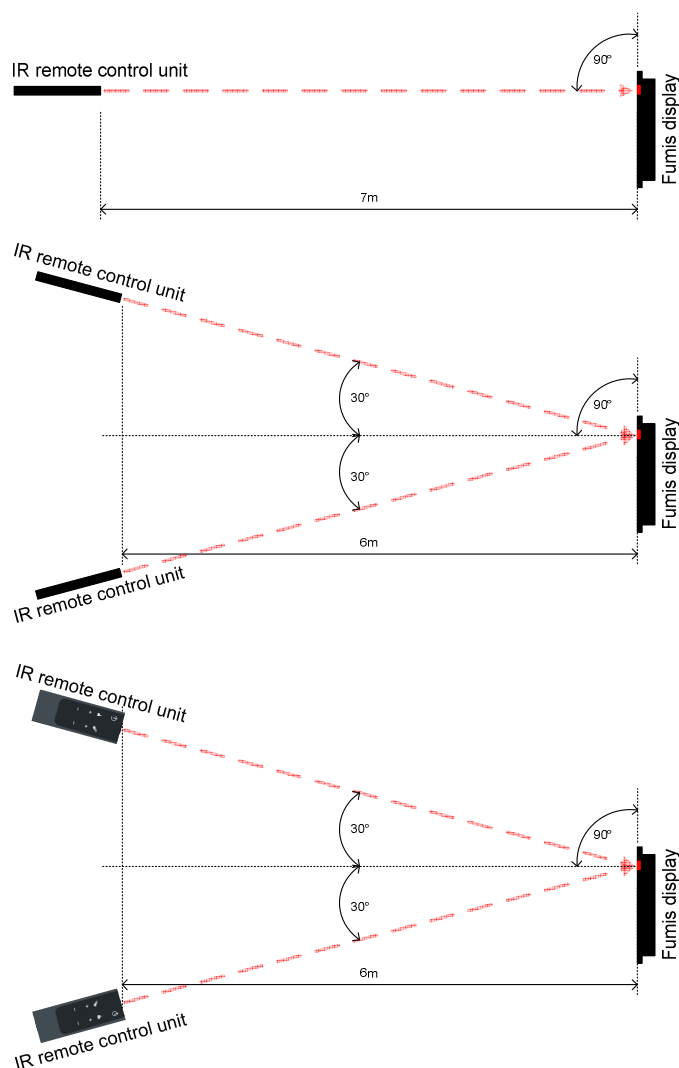

Figure 5: Fumis IR remote controller (operating angles)

### 6.5.3. Automatically by weekly timers

Fumis Premium allows you to set up to 6 different time intervals (Time Interval =  $T_i$ ). Max 3 of them can be used per day. See chapter 6.8 for details.

### 6.5.4. Automatically by Eco Mode

When the temperature rises over the set point, the heating device automatically turns OFF and the screen below appears. It will automatically restart when the temperature falls below the set point (for details see chapter 6.12.).







**Note:**

If the Eco Mode function is not included in your heating device, this screen will never appear.

## 6.6. Changing/selecting the operating power level

Fumis Premium allows you to switch between 5 different power levels.

- Touch the screen (if currently in idle mode) to exit from the idle mode. If the display currently is not in idle mode, skip this step.
- Tap on  to enter the temperature menu
- Tap on  to enter the main menu
- Increase/decrease the operating power level by tapping on  and/or  icons. The changes are saved immediately.

**Note:**



The heating power in kilowatts [kW] depends of the heating device and not of the Fumis Premium user interface.



## 6.7. Changing/selecting the ambient fan speed

Fumis Premium allows you to switch between 5 different ambient fan speeds (6<sup>th</sup> level optional - Hi).

If the **"AUTO"** option is selected (the operating power must also be set to **"AUTO"**), the ambient fan speed follows the automatic power modulation of the heating device.

If the **"Hi"** option is selected, the ambient fan operates at max. speed.

- Touch the screen (if currently in idle mode) to exit from the idle mode. If the display currently is not in idle mode, skip this step.
- Tap on  to enter the temperature menu
- Tap on  to enter the main menu

- Increase/decrease the operating power level by tapping on  and/or  icons. The changes are saved immediately.

**Note:**

This option is only available in air and/or hydro stoves. In boilers, burners and other types of heating devices the ambient fan is not included.

## 6.8. Setting the weekly timers

Fumis Premium allows you to set up to 6 different time intervals (Time Interval = Ti). A maximum of 3 time intervals can be used per day. See the example below which shows the correct and incorrect usage of weekly timers.

The usage shown in table 5 is not correct, because more than 3 time intervals per day are selected.

Ti1	07:00	11:00	20°C
Ti2	06:00	16:00	21°C
Ti3	14:00	22:00	20.5°C
Ti4	19:00	22:00	23°C
Ti5	13:00	21:00	22°C
Ti6	01:00	03:00	16°C

Table 3 – Time intervals (example)

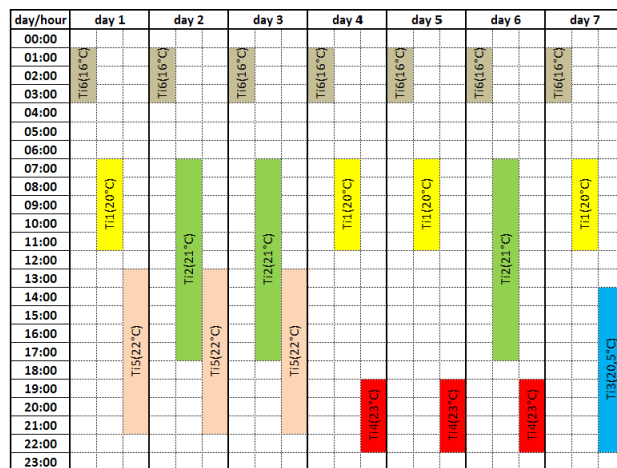

Table 4 – Correct usage of weekly timers (example)

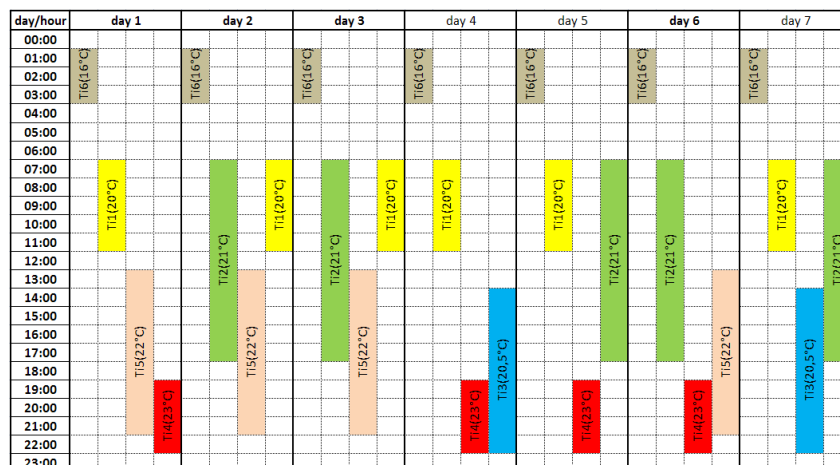













Table 5 – Incorrect usage of weekly timers (example)

To setup the weekly timers follow the steps below:

- Touch the screen (if currently in idle mode) to exit from the idle mode. If the display currently is not in idle mode, skip this step.
- Tap on  to enter the temperature menu
- Tap on  to enter the main menu
- Tap on  to enter the timers menu
- Tap on **"Add new timer"** to add a new timer
- Select the day/days you want the time interval to appear, by tapping on the initial (**M=Monday, 1<sup>st</sup>T=Tuesday, W=Wednesday, 2<sup>nd</sup>T=Thursday, F=Friday, 1<sup>st</sup>S=Saturday, 2<sup>nd</sup>S=Sunday**). The example shows the selection for **M=Monday, 1<sup>st</sup>T=Tuesday, W=Wednesday, 2<sup>nd</sup>T=Thursday, F=Friday** (example: **M T W T F S S**).
- Set the time start (hours and minutes) for the first time interval by tapping on **"Time start"** and then  and/or  icons. Save the settings by tapping on **"OK"**.
- Set the time finish (hours and minutes) for the first time interval by tapping on **"Time finish"** and then  and/or  icons. Save the settings by tapping on **"OK"**.
- Set the target temperature for the first time interval by tapping on  and then  and/or  icons. Save the settings by tapping on **"OK"**. If you change your mind, tap on **"DELETE"** and the time interval will not be saved.
- Once you complete all your weekly timers settings, you must enable the weekly timers operation to make them appear. If you do not enable them, the heating device will not turn ON/OFF automatically. To enable the weekly timers operation, tap on **"ON"** in the timers menu. To disable the weekly timers operation again, tap on **"OFF"** in the timers menu.
- Exit from the timers menu by tapping .

**Note:**

If the actual temperature is already higher than the target temperature inside a time interval which has to be appeared, the heating device will not be turned ON automatically until the actual temperature falls under time intervals target temperature (if the time interval is still active).

## 6.9. Viewing service counters

The Fumis controller monitors the combustion system operation and provides different service counters. The values are read-only and cannot be modified.

---

To see the service counters, follow the steps below:

- Touch the screen (if currently in idle mode) to exit from the idle mode. If the display currently is not in idle mode, skip this step.

- Tap on  to enter the temperature menu

- Tap on  to enter the main menu

- Tap on  to enter the statistics menu

Meaning of service counters:

- o **SC00** (igniter starts - the total number of igniter starts)
- o **SC01** (over temperature events - the total number of over temperature events)
- o **SC02** (missed firings - the total number of over temperature events)
- o **SC03** (on time - the total time the combustion system is plugged in the mains)
- o **SC04** (heating time - the total time the combustion system is burning)
- o **SC05** (service time - the total time the combustion system is burning)

## 6.10. Setting fuel options

Depending on the type of your heating device, Fumis Premium allows to switch between different types of combustible:

- Pellets or similar combustible (olive stones, wood chops, ...) and/or
- wood logs

If your heating device is programmed to use only pellets or similar combustibles, in the fuel menu only the options related to pellets will be displayed.



If your heating device is programmed to use only wood logs as a combustible, in the fuel menu only the options related to wood logs will be displayed.

If your heating device is combined, so programmed for using both, pellets or similar combustible AND wood logs, in the fuel menu the options related to pellets AND wood logs will be displayed.

### 6.10.1. Setting the fuel type

If enabled in your combustion system, Fumis Premium allows to switch between using pellets (or similar combustibles) or wood logs.





To select pellets (or similar combustible), follow the next steps:

- 
- Touch the screen (if currently in idle mode) to exit from the idle mode. If the display currently is not in idle mode, skip this step.
  - Tap on  to enter the temperature menu
  - Tap on  to enter the main menu
  - Tap on  to enter the settings menu
  - Tap on "**Fuel**" to enter the **Fuel** menu
  - By tapping on "**Fuel type**" the fuel type selection switches accordingly. The screen displays "**WOOD**" when wood logs are selected as a combustible and "**PELLETS**" when pellets are selected as a combustible.

### 6.10.2. Setting the fuel quality

If enabled in your combustion system, Fumis Premium allows you to select up to 3 different qualities for pellets (or similar combustible) and 3 for wood logs.

To select the fuel quality, follow the next steps:

- Touch the screen (if currently in idle mode) to exit from the idle mode. If the display currently is not in idle mode, skip this step.
- Tap on  to enter the temperature menu
- Tap on  to enter the main menu
- Tap on  to enter the settings menu
- Tap on "**Fuel**" to enter the **Fuel** menu
- Set the desired fuel quality (for pellets and/or wood logs) by tapping on  and/or  icons. The changes are saved immediately.



### 6.10.3. Enabling the fuel autonomy monitoring

If this function is included on your combustion system, Fumis Premium provides you with modern technology that offers you an accurate and exact reading of your fuel quantity, by displaying the amount of time remaining until you need to refill the tank. This option (if included on your combustion system) has to be enabled.

To enable the fuel autonomy monitoring, follow the next steps:

- Touch the screen (if currently in idle mode) to exit from the idle mode. If the display currently is not in idle mode, skip this step.



- 
- Tap on  to enter the temperature menu
  - Tap on  to enter the main menu
  - Tap on  to enter the settings menu
  - Tap on **"Fuel"** to enter the **Fuel** menu
  - Tap on Fuel autonomy **"ON"**. If this function is included on your combustion system, the Fuel autonomy option will not be shown.

#### 6.10.4. Resetting the fuel autonomy after refilling the fuel tank

After refilling the fuel tank, it's necessary to reset the fuel autonomy.

To reset the fuel autonomy, follow the next steps:

- Touch the screen (if currently in idle mode) to exit from the idle mode. If the display currently is not in idle mode, skip this step.

- Tap on  to enter into the temperature menu

- Tap on  to enter into **"How much fuel?"** menu. The screen below will appear:

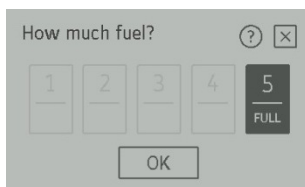

- Tap on 1, 2, 3, 4 or 5, depending on the level until which you refilled the fuel
- Save the settings by tapping on **"OK"**.

### 6.11. Display brightness





Fumis Premium offers different possibilities for setting the display brightness. Thanks to an integrated ambient light sensor, optionally Fumis premium is able also to adapt the display brightness automatically, according to the brightness of the ambient which surrounds it.

Under display settings you are able to:







- Activate the automatic adaptation to the ambient brightness
- Setup the brightness of the display when active

- 
- Setup the brightness of the display when switched to idle mode (after 30 seconds of inactivity)

### 6.11.1. Setting the automatic brightness adaptation

- Touch the screen (if currently in idle mode) to exit from the idle mode. If the display currently is not in idle mode, skip this step.
- Tap on  to enter the temperature menu
- Tap on  to enter the main menu
- Tap on  to enter the settings menu
- Navigate to the "**Display brightness**" by tapping on  and/or 
- Tap on "**Display brightness**" to enter into the **Display brightness** menu
- Tap on "**Automatic ON/OFF**" icon to activate/disactivate the automatic brightness adaptation

### 6.11.2. Setting the active display brightness

- Touch the screen (if currently in idle mode) to exit from the idle mode. If the display currently is not in idle mode, skip this step.
- Tap on  to enter the temperature menu
- Tap on  to enter the main menu
- Tap on  to enter the settings menu
- Navigate to the "**Display brightness**" by tapping on  and/or 
- Tap on "**Display brightness**" to enter into the **Display brightness** menu
- Set the desired active display brightness by tapping on  and/or  icons, next to the "**Active bright.**" label. The changes are saved immediately.

**Note:**







When automatic brightness adaptation is active, this option is disabled.

---

### 6.11.3. Setting the idle display brightness

You can increase or decrease the display brightness in the idle mode to conserve energy. As soon as you touch the keyboard, the brightness of the display will increase to default value.

To setup the idle display brightness follow the steps below:

- Touch the screen (if currently in idle mode) to exit from the idle mode. If the display currently is not in idle mode, skip this step.
- Tap on  to enter the temperature menu
- Tap on  to enter the main menu
- Tap on  to enter the settings menu
- Navigate to the "**Display brightness**" by tapping on  and/or 
- Tap on "**Display brightness**" to enter into the **Display brightness** menu
- Set the desired active display brightness by tapping on  and/or  icons, next to the "**Idle bright.**" label. The changes are saved immediately.

**Note:**

When automatic brightness adaptation is active, this option is disabled.



### 6.12. Enabling the Eco Mode function



When the temperature rises over the set point, the heating device automatically turns OFF and the screen below appears. It will automatically restart when the temperature falls below the set point.

**Note:**

If the Eco Mode function isn't included in your heating device, skip this chapter.

To enable/disable the Eco Mode function, follow the steps below:

- Touch the screen (if currently in idle mode) to exit from the idle mode. If the display currently is not in idle mode, skip this step.
- Tap on  to enter the temperature menu
- Tap on  to enter the main menu
- Tap on  to enter the settings menu

- 
- Navigate to the "**Temp. offsets**" by tapping on  and/or 
  - Tap on "**Temp. offsets**" to enter into the **Temp. offsets** menu
  - Activate/deactivate the Eco Mode function by tapping the "**ON/OFF**" icon

After activating the Eco Mode, the heating device will automatically turn ON/OFF according to the temperature set point.

**Note:**

For detailed description of the Eco Mode function, refer to the user guide of your heating device.

## 6.13. Idle display mode settings

Fumis Premium automatically switches to idle mode after 30 seconds of inactivity and exits from it when touched again. Depending on the settings for the idle mode, the screen in idle mode displays:





- the clock only
- the AIR temperature (if AIR temperature enabled in the heating devices software) only
- the WATER temperature (if WATER temperature enabled in the heating devices software) only
- Switching between the clock and AIR temperature (if AIR temperature enabled in the heating devices software)
- Switching between the clock and WATER temperature (if WATER temperature enabled in the heating devices software)
- Switching between the clock, AIR temperature and WATER temperature (if AIR and WATER temperature enabled in the heating devices software)
- The state of the heating device (when the heating device is in OFF state)
- The fuel autonomy (if enabled in the Fumis Premium and supported by the heating devices software)
- Errors/alerts (if present)

**Note:**

It never switches to idle mode from the service menu.

To setup the idle display mode settings follow the steps below:

- Touch the screen (if currently in idle mode) to exit from the idle mode. If the display currently is not in idle mode, skip this step.
- Tap on  to enter the temperature menu

- Tap on  to enter the main menu
- Tap on  to enter the settings menu
- Navigate to the "**Display settings**" by tapping on  and/or 
- Tap on "**Idle display mode**" to enter into the **Idle display mode** menu
- Activate the info you want to be displayed in idle mode by tapping the "**ON/OFF**" icon:

Example:

If you want to activate the air temperature monitoring in idle mode, tap on the "**ON/OFF**" icon next to the **Air temp** label.

If you want to activate the water temperature monitoring in idle mode, tap on the "**ON/OFF**" icon next to the **Water temp** label.

If you want to activate the clock monitoring in idle mode, tap on the "**ON/OFF**" icon next to the **Time** label.

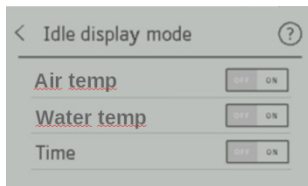







## 6.14. Setting the temperature unit (°C/°F)

Fumis Premium allows you to choose between displaying the temperature in °C (degrees Celsius) or in °F (degrees Fahrenheit).

To select the desired temperature unit, follow the steps below:

- Touch the screen (if currently in idle mode) to exit from the idle mode. If the display currently is not in idle mode, skip this step.







- Tap on  to enter the temperature menu
- Tap on  to enter the main menu
- Tap on  to enter the settings menu
- Navigate to the "**Temperature unit**" by tapping on  and/or 
- Tap on "**Temperature unit**" to enter into the **Temperature unit** menu

- 
- Select the desired temperature unit by tapping on  and/or  icons

## 6.15. Setting the speaker volume

Fumis Premium allows you to set the volume of the integrated speaker, or to turn it completely OFF.





To set the desired speaker volume, follow the steps below:



- Touch the screen (if currently in idle mode) to exit from the idle mode. If the display currently is not in idle mode, skip this step.
- Tap on  to enter the temperature menu
- Tap on  to enter the main menu
- Tap on  to enter the settings menu
- Navigate to the "**Speaker volume**" by tapping on  and/or 
- Tap on "**Speaker volume**" to enter into the **Speaker volume** menu
- Set the desired speaker volume, or turn it completely OFF, by tapping on  and/or  icons

## 6.16. Setting the antifreeze temperature

Fumis Premium allows you to set the minimum ambient temperature to maintain. For example, if you are not at home for a few days and the weather gets extremely cold, there is a risk, that the temperature inside the house may fall under the freezing point and damage the water pipes inside the walls of your house.

To setup the antifreeze temperature, follow the steps below:

- Touch the screen (if currently in idle mode) to exit from the idle mode. If the display currently is not in idle mode, skip this step.
- Tap on  to enter the temperature menu
- Tap on  to enter the main menu
- Tap on  to enter the settings menu
- Navigate to the "**Antifreeze**" by tapping on  and/or 

- Tap on "**Antifreeze**" to enter into the **Antifreeze** menu
- Set the desired antifreeze temperature, or disable the antifreeze option by tapping on  and/or  icons. The changes are saved immediately.







**Note:**

The antifreeze temperature option is available only when timers are activated.

## 6.17. Using the manual feeding function

Before turning on your heating device for the first time (or in case you ran out of combustible), the feeder screw may be completely empty and due to this fact the ignition may fail. To avoid this, Fumis premium allows you to refill the feeder screw before starting up or restarting the heating device.

To activate the manual feeding, follow the steps below:

- Touch the screen (if currently in idle mode) to exit from the idle mode. If the display currently is not in idle mode, skip this step.
- Tap on  to enter the temperature menu
- Tap on  to enter the main menu
- Tap on  to enter the settings menu
- Navigate to the "**Manual feed**" by tapping on  and/or 
- Tap on "**Manual feed**" to enter into the **Manual feed** menu
- Activate the manual feeding by **holding** the  icon. After holding the icon for 30 seconds, the manual feeding will be automatically deactivated again. If 30 seconds were not enough to refill the feeder screw, hold the icon again. Repeat it until the first pellets starts to fall into the burning pot.

**Note:**

The manual feeding option is only available in heating devices which are equipped with a feeder. The manual feeding during the operation of the heating device cannot be activated. If your heating device is equipped with a pressure safety switch, simultaneously with the feeder, the combustion fan will also be activated.

---

## 6.18. Checking the time to service

Fumis Premium allows you to check the time when you should contact the service personnel to perform regular maintenance on your combustion system. This value is read-only and can be modified by authorised personnel only.

To check the time to service, follow the steps below:

- Touch the screen (if currently in idle mode) to exit from the idle mode. If the display currently is not in idle mode, skip this step.

- Tap on  to enter the temperature menu

- Tap on  to enter the main menu

- Tap on  to enter the settings menu

- Navigate to the "**Timo to service**" by tapping on  and/or 

- Tap on "**Timo to service**" to see the remaining **Time to service**

### Note:

When the time to service expires, the Fumis Premium warns you by displaying the A002 alert (Call service for regular maintenance). The heating device is still operational. To reset this alert, call authorised personnel.

If your heating device does not require regular maintenance, the **Time to service** option is skipped in the settings menu.

## 6.19. Using the screen lock function

Fumis Premium allows you to lock the screen in order to prevent accidental changes of the settings. With the screen lock enabled, you can navigate the menu to display current values, but you cannot edit any of the settings, except the screen lock itself. Note that this option does not disable the Fumis IR (Infra Red) remote control. The screen lock setting offers the following options:

**OFF:** the screen lock is disabled, all functions are available

**Lo:** impossible to change settings, only possible to turn ON/OFF the heating device. When this option is selected, the black  icon appears in idle screen and main menu screen.

**Hi:** all the functions are locked (also turning ON/OFF the heating device), only return to **Lo** or **OFF**

option is enabled). When this option is selected, the red  icon appears in idle screen and main menu screen.





### Tip

We recommend you use the screen lock option if children are able to access the keyboard without adult supervision.



---

To use the screen lock function, follow the steps below:





- Touch the screen (if currently in idle mode) to exit from the idle mode. If the display currently is not in idle mode, skip this step.
- Tap on  to enter the temperature menu
- Tap on  to enter the main menu
- Tap on  to enter the settings menu
- Navigate to the "**Screen lock**" by tapping on  and/or 
- Tap on "**Screen lock**" to switch between **screen lock - OFF**, **screen lock - Lo** and **screen lock - Hi**.

## 6.20. Using the display cleaning function

Fumis Premium includes a functionality, which makes the display inactive for 30 seconds. This allows you to clean the display easier (if needed), because you prevent accidental changes to the settings.

If the default 30 seconds are not enough to clean the display, you can reactivate the "**Display cleaning**" function.

To use the display cleaning function, follow the steps below:

- Touch the screen (if currently in idle mode) to exit from the idle mode. If the display currently isn't in idle mode, skip this step.
- Tap on  to enter the temperature menu
- Tap on  to enter the main menu
- Tap on  to enter the settings menu
- Navigate to the "**Display cleaning**" by tapping on  and/or 
- Tap on "**Display cleaning**" to enter into the **Display cleaning** menu
- Tap on "**START**" icon to start the 30 seconds countdown

### Note

If the heating device turns on automatically (by timer, room thermostat, etc.), the cleaning function gets interrupted in the moment when the heating device turns ON.







The display cleaning function cannot be activated during the operation of the heating device.

---

## 6.21. Setting the language





Fumis Premium allows you to choose between different languages.

To set the desired language, follow the steps below:

- Touch the screen (if currently in idle mode) to exit from the idle mode. If the display currently is not in idle mode, skip this step.
- Tap on  to enter the temperature menu
- Tap on  to enter the main menu
- Tap on  to enter the settings menu
- Navigate to the "**Language**" by tapping on  and/or 
- Tap on "**Language**" to enter into the **Language** menu
- Navigate to the **desired language** by tapping on  and/or 
- Tap on the language you want to select. The change is saved immediately and appears in the upper left corner of the screen.

## 6.22. Checking the firmware version





To check the version of the firmware currently installed on the Fumis controller and Fumis Premium user interface, follow the steps below:

- Touch the screen (if currently in idle mode) to exit from the idle mode. If the display currently is not in idle mode, skip this step.
- Tap on  to enter the temperature menu
- Tap on  to enter the main menu
- Tap on  to enter the settings menu
- Navigate to the "**Info**" by tapping on  and/or 
- Tap on "**Info**" to see the currently installed firmware.

---

## 6.23. Using the tips

For easier usage of the Fumis Premium you can make use of the tips

- Touch the screen (if currently in idle mode) to exit from the idle mode. If the display currently is not in idle mode, skip this step.
- Tap on  to enter the temperature menu
- Tap on  to enter the main menu
- Tap on  to enter the settings menu
- Navigate to the "**Tips**" by tapping on  and/or 
- Tap on "**Tips**" to enter into the "**Tips**" menu
- Tap on the tip you want to view

## 6.24. Entering into the service menu

Fumis premium allows parameters modifications only through the Service menu, accessible through a dedicated password. Modifying the parameters may alter the combustion system function, cause malfunction and even cause damage, ATech advises customers to allow only trained professionals to make parameter modifications and not the final user.

### 6.24.1. Modifying the parameters

The parameters are used to fine tune the operation of the combustion system with the Fumis Alpha controller. Set the parameter values of the Fumis Alpha controller, according to the selected configuration, to optimise the performance of the combustion system.

With the Fumis Premium you can modify the parameter values, but you cannot change the valid parameter range settings (parameters limits). The valid parameter range settings are set in the configuration procedure in the Fumis PC-PPO application.

Default range for a parameter is between 0-255, but this range can be further limited during the configuration procedure. With the Fumis Premium you can enter the parameter value within the set valid range.

**Note:**

It is recommended to use the Fumis PC-PRO application for modifying the parameters.

---

## 6.24.2. Input and output diagnostics

For diagnostic purposes you can digitally test the inputs and outputs.

In the service menu you can view the state of the digital and analogue inputs. The values are read-only and cannot be modified.

Additionally, you can view the state of the digital outputs. While the combustion system operates, the values are read-only. If the combustion system is off, the values can be modified.

## 6.24.3. Viewing and resetting the service counters

The Fumis Alpha controller monitors the combustion system operation and provides different service counters. The values are read-only and cannot be modified.

### Meaning of service counters:

- **SC00** (igniter starts - the total number of igniter starts)
- **SC01** (over temperature events - the total number of over temperature events)
- **SC02** (missed firings - the total number of over temperature events)
- **SC03** (on time - the total time the combustion system is plugged in the mains)
- **SC04** (heating time - the total time the combustion system is burning)
- **SC05** (service time - the total time the combustion system is burning)
- **SC06** (RESET)

To reset the service counters navigate to the **"SC06"** and tap on **"RESET"** icon.

## 6.24.4. Viewing logs

Fumis ALPHA controller offers event and error logging and can store up to 15 logs. Logs are available in the service menu.

Each log contains the date and time of the event/error, log code and log data. When logs are full, they are overwritten from the oldest one up.

## 7. Troubleshooting

The Fumis Premium provides notifications and warnings for alerts and errors, which can occur when using the heating device.

In case of an alert, the Fumis Premium warns you by displaying the alerts description in yellow, while in case of an error, its description is displayed in red.

In case of an alert, the combustion system is still operational, in case of an error the combustion system is seriously malfunctioning and the service personnel should be contacted.

Each alert and error also has a code, which can be used to identify the problem.

## 7.1. Alerts and errors

Alert/error code	Alert/error description	Label on the screen when the heating device is controlled by Fumis Alpha 40 controller	Label on the screen when the heating device is controlled by Fumis Alpha 41 or 42 controller	Label on the screen when the heating device is controlled by Fumis Alpha 60, 65, 70 or 75 controller
A001	Low fuel	Warning fuel level, refuel the tank.	Warning fuel level, refuel the tank.	Warning fuel level, refuel the tank.
A002	Maintenance	Time to service expired, call service for regular maintenance.	Time to service expired, call service for regular maintenance.	Time to service expired, call service for regular maintenance.
A003	Cleaning	Flue gases temperature warning level. Chimney or heat exchanger cleaning required.	Flue gases temperature warning level. Chimney or heat exchanger cleaning required.	Flue gases temperature warning level. Chimney or heat exchanger cleaning required.
A004	Low battery	Low battery, call service for its replacement.	Low battery, call service for its replacement.	Low battery, call service for its replacement.
A005	Speed sensor	Speed sensor failure, call service.	Speed sensor failure, call service.	Speed sensor failure, call service.
A006	Door opened	Door open, close the door.	Door open, close the door.	Door open, close the door.
A007	Pressure/airflow sensor	Alternative operating mode, limited function. Airflow sensor malfunctioned, call service.	Alternative operating mode, limited function. Airflow sensor malfunctioned, call service.	Alternative operating mode, limited function. Airflow sensor malfunctioned, call service.
E002	IR communication error	Infrared sensor malfunctioned, call service.	Infrared sensor malfunctioned, call service.	Infrared sensor malfunctioned, call service.
E004	MB communication error	MB communication error	MB communication error	MB communication error
E101	Fire error	Error, caused by: 1. Ignition failed, 2. water over temperature, 3. backfire protection	Error, caused by: 1. Ignition failed, 2. water over temperature, 3. backfire protection	Error, caused by: 1. Ignition failed, 2. water over temperature, 3. backfire protection

<b>E102</b>	Chimney dirty	Error, caused by: 1. Chimney, air inlet tube or burning pot dirty. 2. manually stopped device before flame detection.	Error, caused by: 1. Chimney, air inlet tube or burning pot dirty. 2. manually stopped device before flame detection.	Error, caused by: 1. Chimney, air inlet tube or burning pot dirty. 2. manually stopped device before flame detection.
<b>E105</b>	NTC2	Never triggered	Never triggered	Sensor connected to T02 malfunctioned or disconnected. Call service.
<b>E106</b>	NTC3	Sensor connected to T05 malfunctioned or disconnected. Call service.	Sensor connected to T03 malfunctioned or disconnected. Call service.	Sensor connected to T05 malfunctioned or disconnected. Call service.
<b>E107</b>	TC2	Never triggered	Never triggered	Sensor connected to T04 malfunctioned or disconnected. Call service.
<b>E108</b>	Security switch error	Security switch connected to I01 switched OFF. Reset the alarm and restart the device. If the error persists, call service.	Security switch connected to I01 switched OFF. Reset the alarm and restart the device. If the error persists, call service.	Security switch connected to I01 switched OFF. Reset the alarm and restart the device. If the error persists, call service.
<b>E109</b>	Pressure switch error	Never triggered	Never triggered	Pressure sensor switched OFF. Reset the alarm and restart the device. If the error persists, call service.
<b>E110</b>	NTC1	Sensor connected to T02 malfunctioned or disconnected. Call service.	Sensor connected to T02 malfunctioned or disconnected. Call service.	Sensor connected to T01 malfunctioned or disconnected. Call service.
<b>E111</b>	TC1	Sensor connected to T03 malfunctioned or disconnected. Call service.	Sensor connected to T01 malfunctioned or disconnected. Call service.	Sensor connected to T03 malfunctioned or disconnected. Call service.
<b>E113</b>	Gases over temperature	Flue gases over temperature. Chimney or heat exchanger cleaning required.	Flue gases over temperature. Chimney or heat exchanger cleaning required.	Flue gases over temperature. Chimney or heat exchanger cleaning required.
<b>E114</b>	No pellets	Fuel Ignition timeout expired (empty the burning pot and restart the device) or fuel tank empty (refuel the tank).	Fuel Ignition timeout expired (empty the burning pot and restart the device) or fuel tank empty (refuel the tank).	Fuel Ignition timeout expired (empty the burning pot and restart the device) or fuel tank empty (refuel the tank).
<b>E115</b>	General error	Call service.	Call service.	Call service.

Table 6 – Errors/alerts

---

## 7.2. Resetting the alerts and errors

### 7.2.1. Resetting the alerts

In case of an alert, the screen displays a yellow message with the alerts description (see an example below).



To close the alert screen, tap on . Closing the alert screen does not reset the alert. After closing the alert screen with , the alert code is still present in the upper left corner of the main screen as well as on all idle mode screens (see an example below).

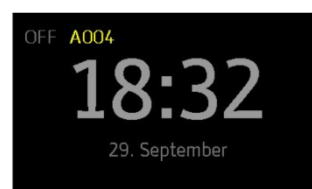
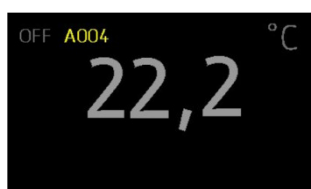

To see the alert message again, tap on the alert code in the upper left corner, in this example **A004**.

To reset the alert, the issue must be solved. In this example, the battery must be replaced.

#### Note:

In case of an alert, the heating device is still operational (in some cases has limited functions).

### 7.2.2. Resetting the errors

In case of an error, the screen displays a red message with the errors description (see an example below).



To close the error screen, tap on . Closing the error screen does not reset the error. After closing the error screen with , the error code is still present in the upper left corner of the main screen as well as on all idle mode screens (see an example below).

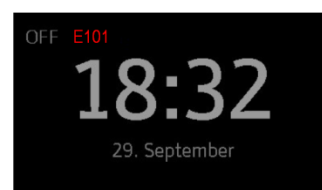

---

To see the error message again, tap on the error code in the upper left corner, in this example **E101**.

To reset the error, the issue must be solved. Until this, the heating device is not operational.

**Note:**

In case of an error, the heating device is not operational until the repairs are made.





© ATech elektronika d.o.o., 2012. All rights reserved.

[www.Fumis.si](http://www.Fumis.si)

[www.ATech.si](http://www.ATech.si)

Support: [support@Fumis.si](mailto:support@Fumis.si)

ATech elektronika d.o.o., Bač pri Materiji 30, SI-6242 Materija, Slovenia  
NC: +386 (0)8 200 88 00, Fax: +386 (0)8 200 88 01, E: info@Fumis.si